

# NOTICE

AL-F-131G

Barre de stabilisation pour paroi de douche 90cm recoupable en aluminium anodisé pour verre entre 6mm et 8mm

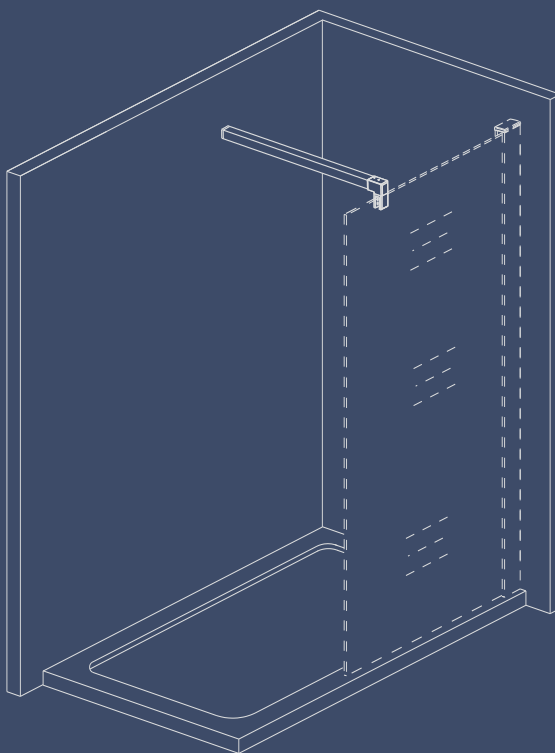

# ÉQUIPEMENT DE PROTECTION



# PRÉCAUTIONS

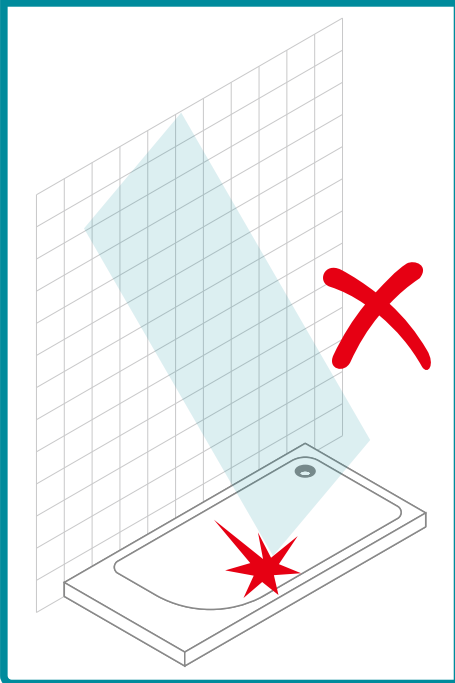
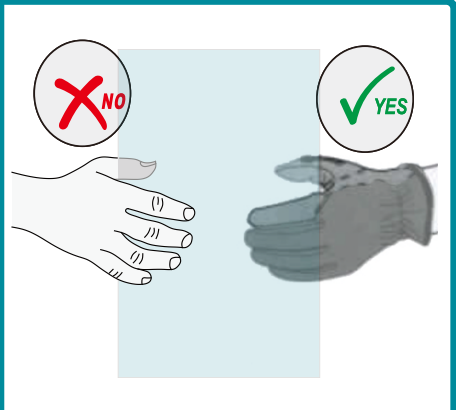
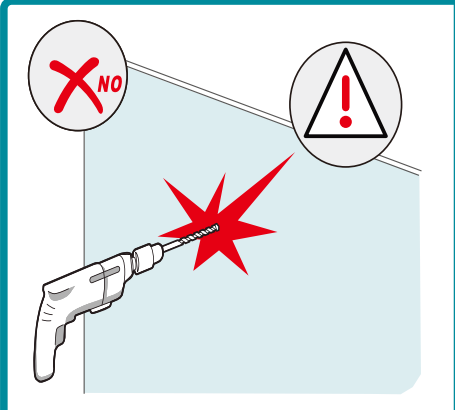

# OUTILS NÉCESSAIRES

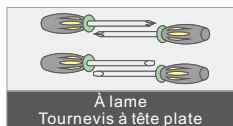
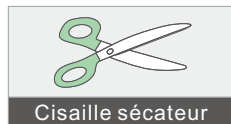
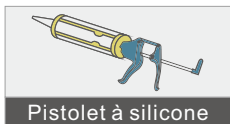
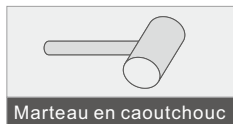
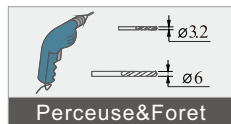
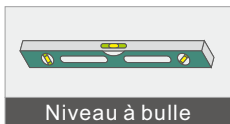
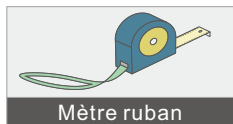

# LIST D'ACCESSOIRE

**A** B-358-G

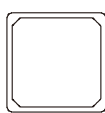

X1

**B** E1-171-G

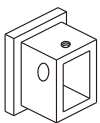

X1

**C** H-044-G

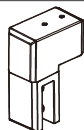

X1

**D** ST4X30

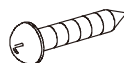

X1

**E** M4X12

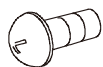

X1

**F** ST4X12

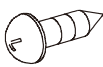

X1

**G** I-432



X1

1

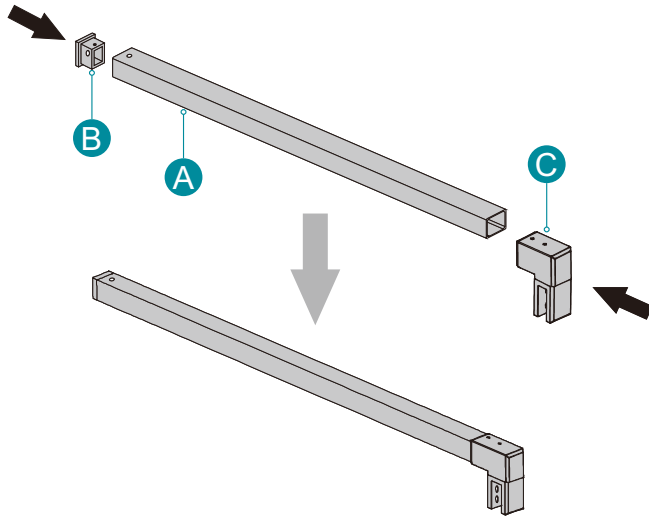

2

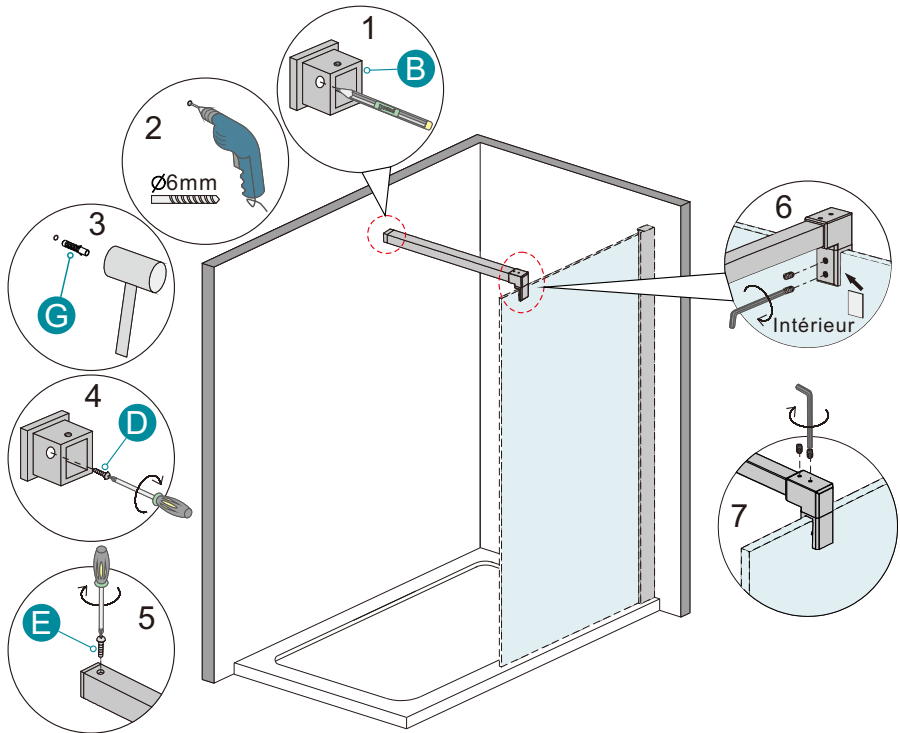

02

## Schéma du montage

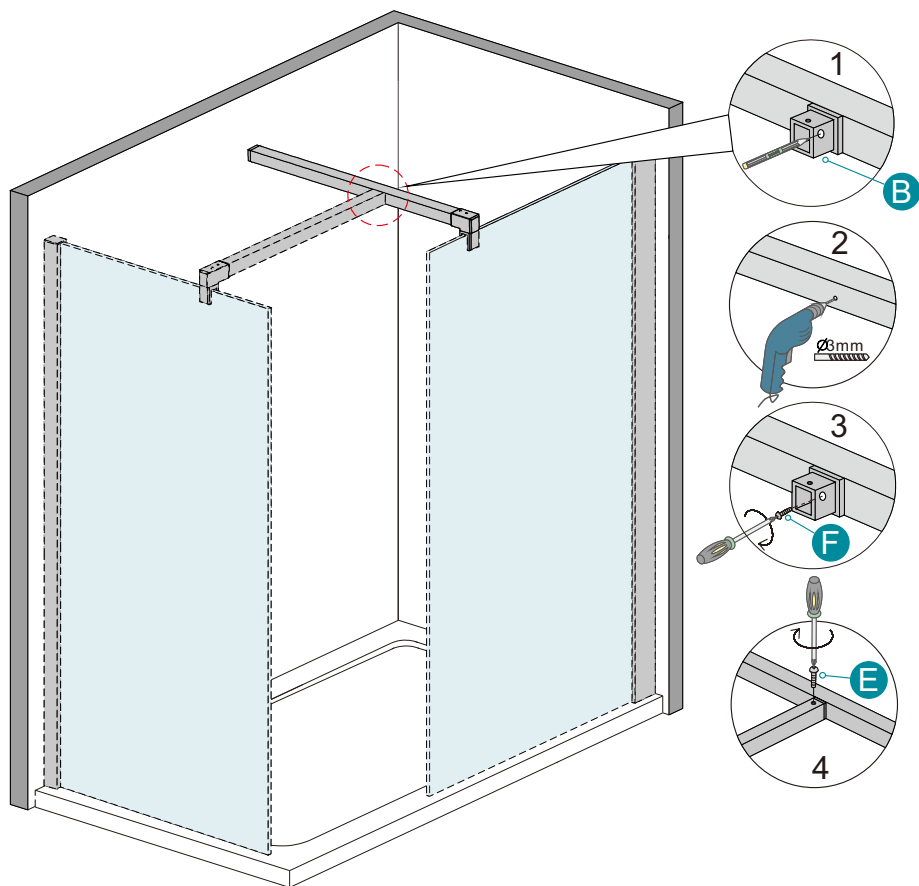

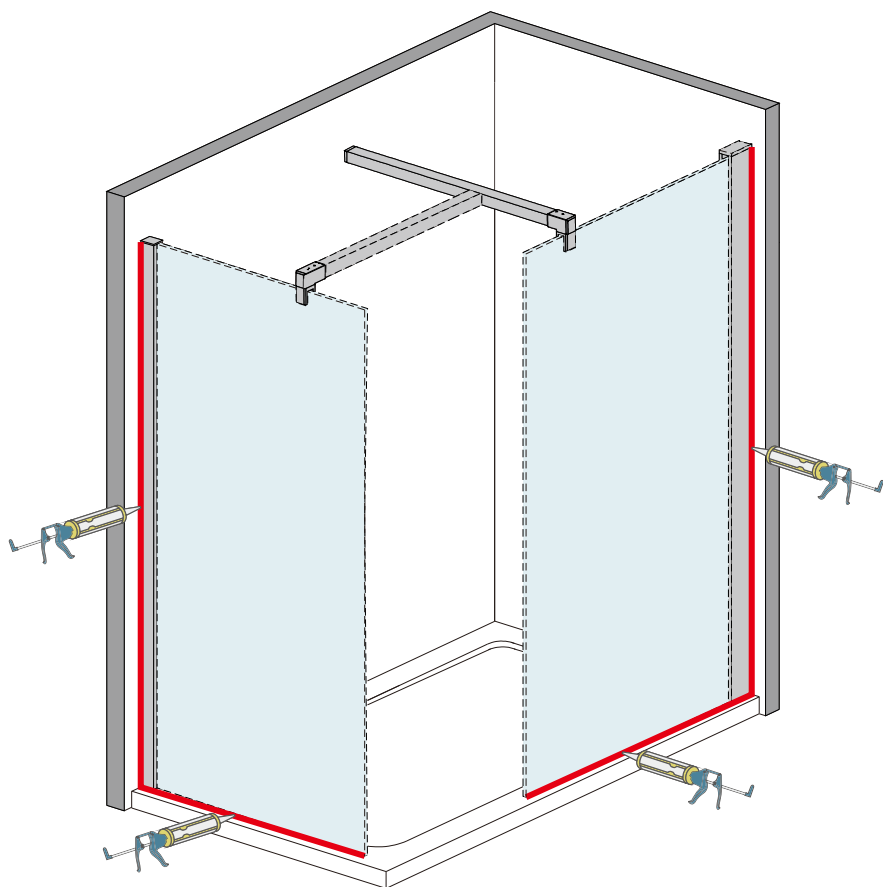

Mettez un joint en silicone à l'extérieur de la porte de douche (entre le profilé mural et le mur et entre le cadre/la baguette et le receveur). Pas de douche dans les 24h après le montage

## NETTOYAGE & ENTRETIEN

Enlevez les déchets régulièrement afin d'éviter le blocage des fuites.

En général, vous pouvez nettoyer la paroi de douche avec une serpillère et des détergents doux.

Veillez ne pas nettoyer la paroi de douche avec des détergents forts comme l'alcool, l'essence ou autres nettoyeurs chimiques.

Si il y'a des taches sur la paroi, vous pouvez utiliser un calicot et du dentifrice pour la nettoyer, en veillant à bien rincer avec de l'eau après.

Après l'installation, si il y'a du bruit lorsque vous pivotez la porte, vous pouvez appliquer un peu de lubrifiant sur les rouleaux, les charnières et les glissières.