

NOTICE

GV2-**E-97

Porte de douche battante de hauteur 197cm
en verre 6 mm transparent anticalcaire

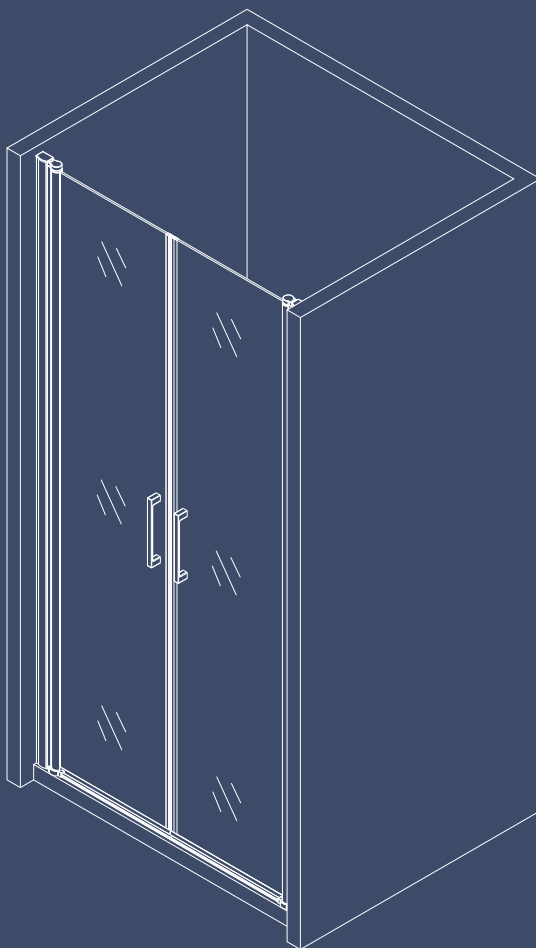

ÉQUIPEMENT DE PROTECTION



PRÉCAUTIONS

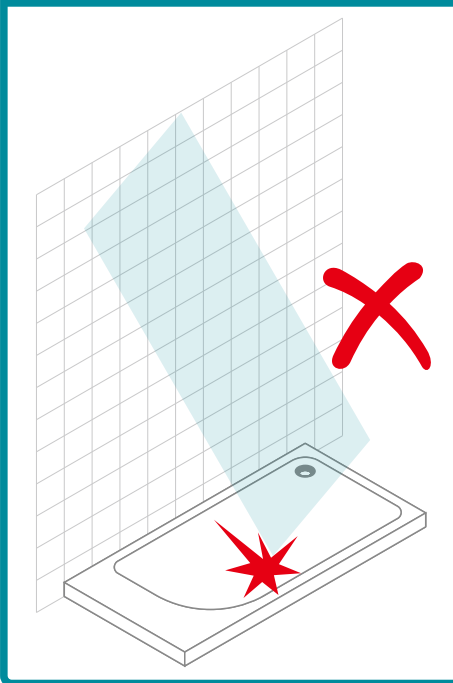
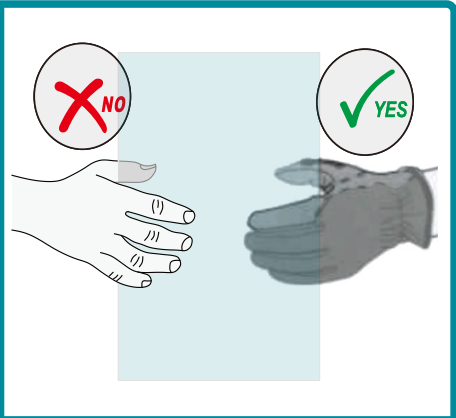
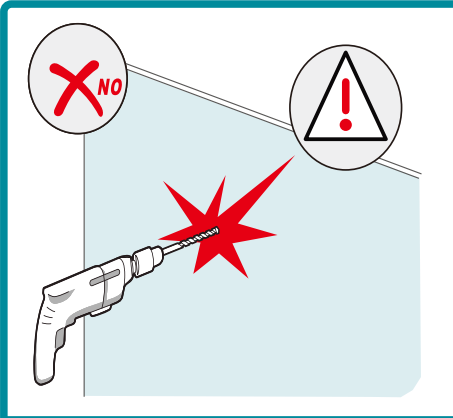

OUTILS NÉCESSAIRES

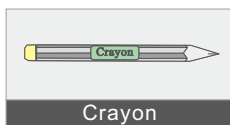
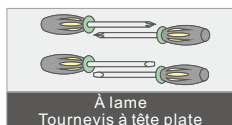
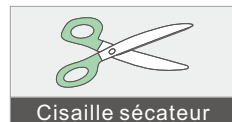
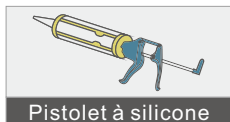
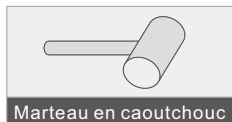
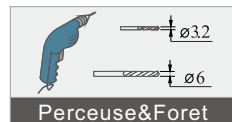
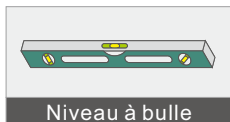
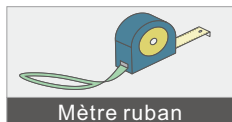

LIST D'ACCESSOIRE









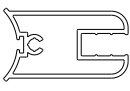
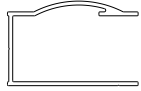
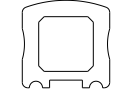
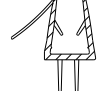

- | | | | | |
|--------------------------------------------------------------------------------------------------------------------|--------------------------------------------------------------------------------------------------------------|-------------------------------------------------------------------------------------------------------------|-------------------------------------------------------------------------------------------------------------|--------------------------------------------------------------------------------------------------------------------|
| A B-256

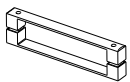
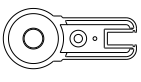
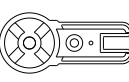
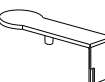
X2 | B B-260

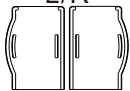
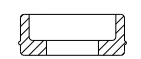
X2 | C B-041

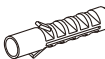
X1 | D C-165

X2 | E C-001

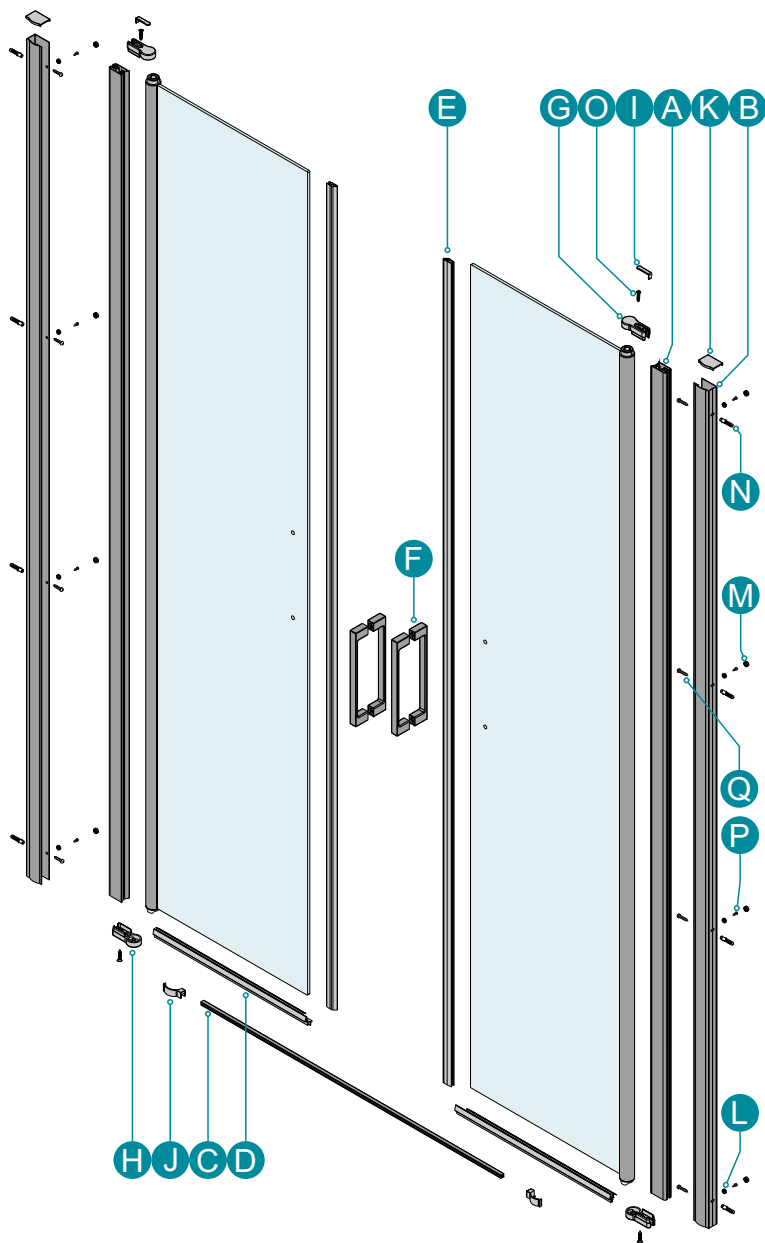
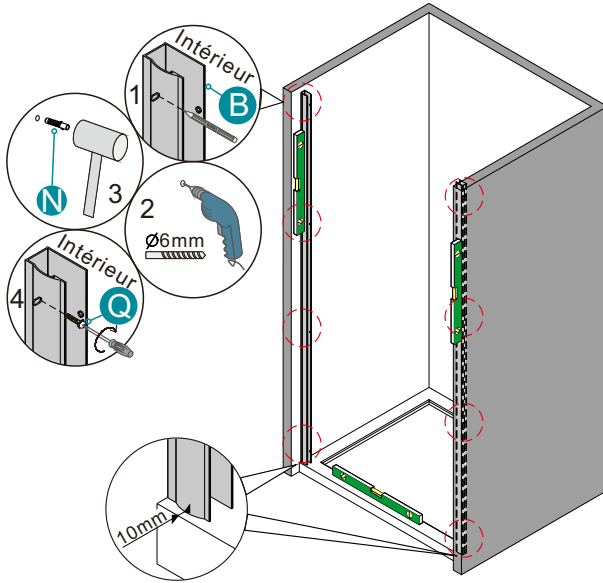
X2 |
| F E-021

X2 | G I-248

X2 | H I-247

X2 | I I-249

X2 | J I-605
L/R

X2 |
| K I-253
L/R

X2 | L I-062

X8 | M I-065

X8 | N I-432

X8 | O ST4X30

X4 |
| P ST4X12

X8 | Q ST4X30

X8 | | | |

SCHÉMA DU PRODUIT



1



2

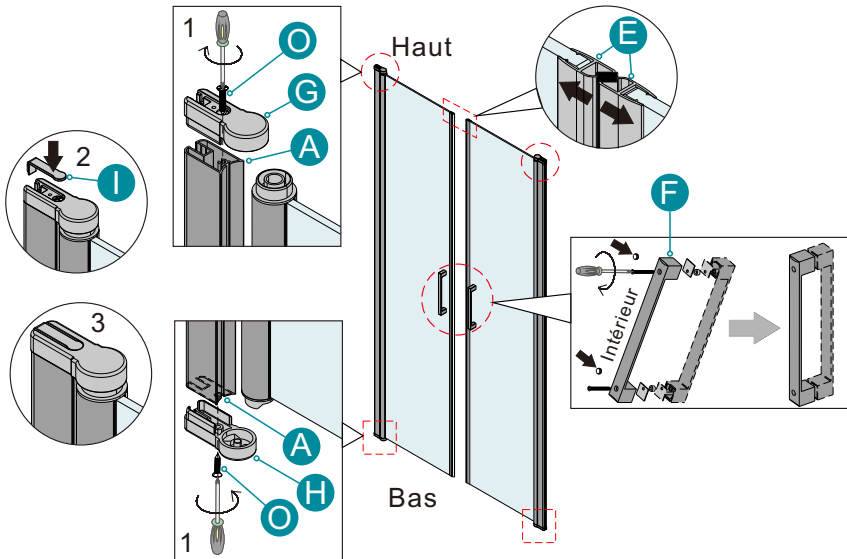

3

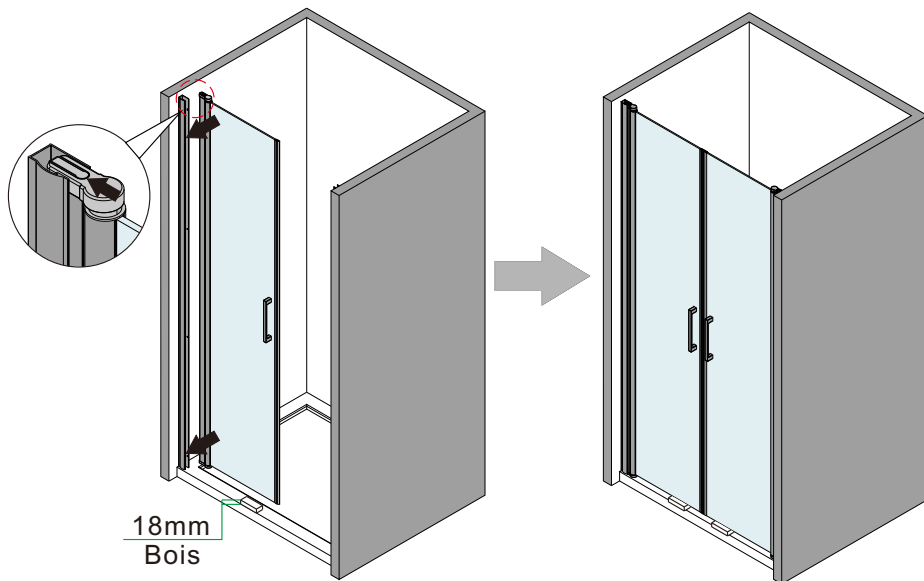

4

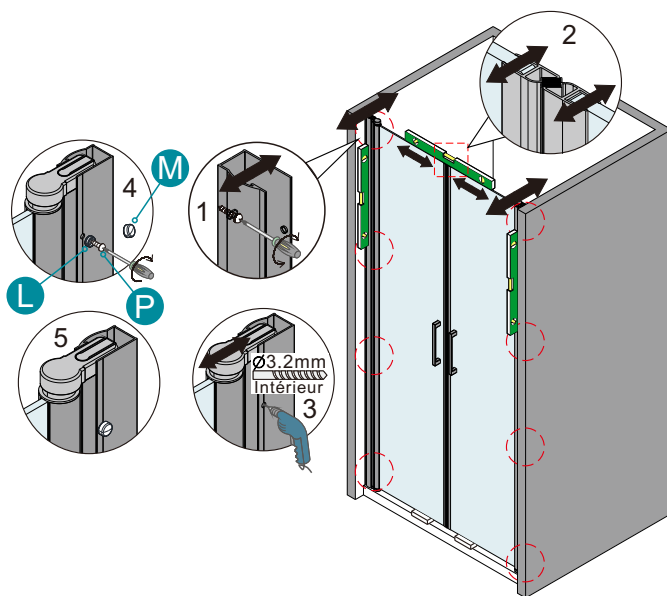

5

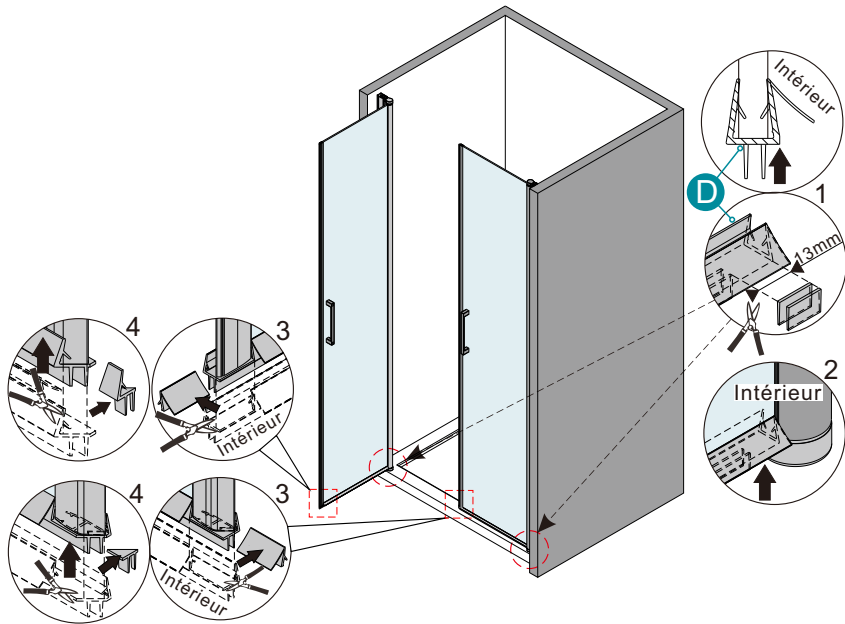

6

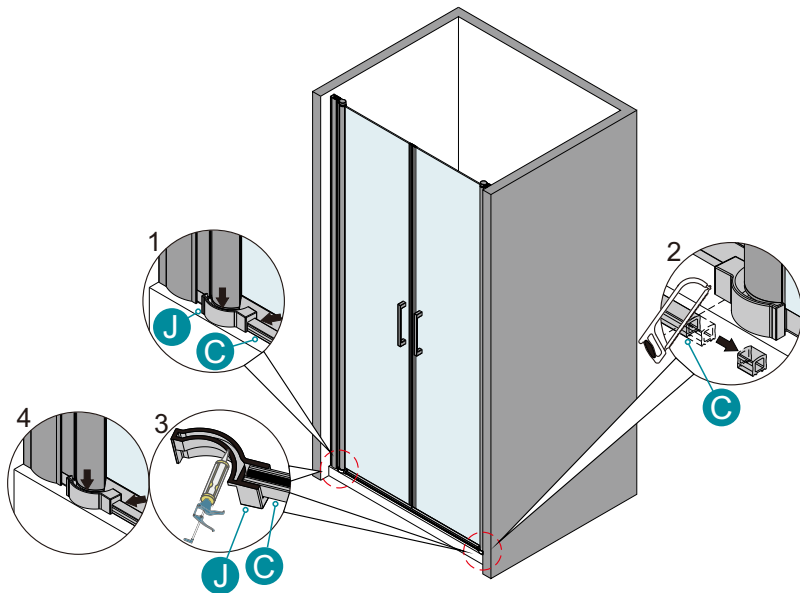

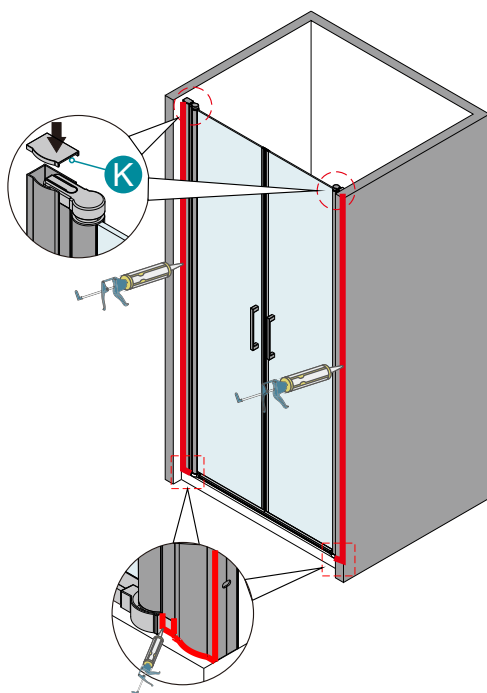

Mettez la silicone à l'extérieur de la porte de douche (entre le profilé mural et le mur et entre le cadre/la baguette et le receveur). Pas de douche dans 24h après le montage.

NETTOYAGE & ENTRETIEN

Enlevez les déchets régulièrement afin d'éviter le blocage de la fuite.

En général, vous pouvez nettoyer la paroi de douche avec une serpillière et des détergents doux.

Veillez ne pas nettoyer la paroi de douche avec des détergents forts comme l'alcool, l'essence ou autres nettoyeurs chimiques.

S'il y a des taches sur la paroi, vous pouvez utiliser un calicot avec du dentifrice pour la nettoyer, cependant, vous devrez la rincer avec de l'eau après.

Lorsque vous finissez l'installation et s'il y a du bruit quand vous pivotez la porte, vous pouvez appliquer un peu de lubrifiant sur les rouleaux, les charnières et la glissière.